

# FC Series

## Interactive Flat-Panel Display

### User Guide

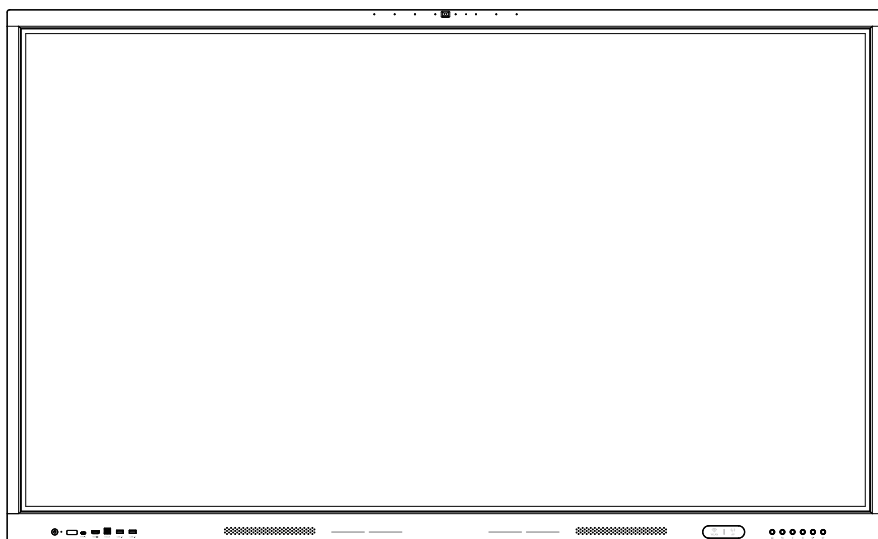

# Table of Contents

---

Instructions .....	1
Safety Warning .....	1
Package Contents .....	3
Installation Steps .....	4
Product Function Description .....	7
External Computer & Touch Control Connection .....	12
Interface function .....	13
Remote Control Function Keys Description .....	14
Installing the OPS computer (Optional) .....	15
Maintenance .....	16
Hazardous Materials Table .....	17

# Instructions

---

Thank you for choosing our product. We sincerely hope that our Smart Interactive Flat-Panel can bring convenience to your team cooperation. Before using the product, please carefully read the User Guide, as it briefly describes the steps to start using this product.

## Note:

- ⦿ We reserve the right to improve the products described in this user manual, and no further notice will be given in the event of changes.
- ⦿ For any discrepancies between the information, images, and textual explanations in this user manual, please refer to the actual product.

## Important Safety, Compliance and Warranty Information



# SAFETY WARNING!

---

## Placement

- Please do not place the product in unstable or easily tilted locations.
- Please avoid placing the product in areas where direct sunlight can reach, near heating devices such as electric heaters, or other heat sources and strong light sources.
- Please avoid placing the product near devices with strong radiation.
- Please do not place the product in damp or liquid-splashed areas.

## Power

- Please check and ensure that the voltage value on the nameplate of the rear shell matches the main power supply voltage.
- Please unplug the power cord and antenna plug during thunderstorms and lightning weather.
- Please unplug the power plug when there is no one indoors or when not in use for a long time.
- Please avoid physical or mechanical damage to the power cord.
- Please use a dedicated power cord and do not modify or extend the power cord.
- Please check and ensure that the ground wire of the AC power cord is connected, otherwise it may cause abnormal touch writing.

## Screen

- Please do not use hard or sharp objects instead of our supplied writing pens on the screen to avoid affecting the visual effect and writing.
- Please unplug the power before cleaning the product. Use a soft, dust-free, and dry cloth to clean the screen.
- Please do not use water or liquid detergent to clean the product.
- Please contact the authorized reseller for thorough cleaning.
- Please do not display a high-brightness image on the screen for a long time.

## Temperature & Humidity

- Do not place this product near electric heaters or radiators.
- When moving the product from a low-temperature area to a high-temperature area, please allow it to sit for some time to ensure that any internal condensation dissipates before powering it on.
- The operating temperature of the product is 0°C – 40°C.
- Do not expose this display to rain, moisture, or areas near water.
- Please ensure indoor dryness and ventilation.

## Ventilation

- Please place the product in a well-ventilated area to ensure good heat dissipation.
- Please place the product in an area with adequate ventilation, leaving at least a 10cm-space on the left, right, and back, and a 20cm-space above the product.

## Disclaimer

### **The following circumstances are excluded from warranty coverage:**

- Product damage caused by catastrophes, lightning strikes, faulty electric power, and environmental factors.
- Defacement of product labeling (label alterations and falsification, missing serial numbers, serial numbers no longer discernible, or invalid serial numbers). All serial numbers are recorded and tracked for warranty purposes.
- Unauthorized changes to non-parts, modifications or alterations, or removal of parts from the products.
- Damage caused by operator error or failure to comply with user manual instructions, such as improper storage resulting in the product getting wet, corrosion, falling, being squeezed, or exposure to inadequate temperature/humidity environments.
- Accessories or packing materials such as boxes, user manuals, etc.

# Package Contents

---

Before use, please ensure that the following items are included in the package.  
If anything is missing, please contact the retailer where you purchased the product.

## Interactive Flat-Panel

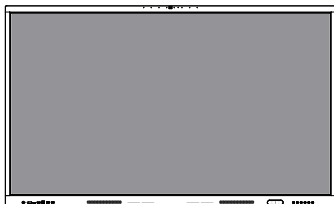

## Power Cord

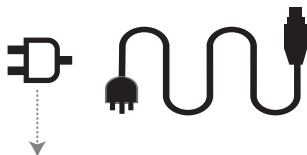

Note: The power cord may vary depending on the region.

## Remote Control



## Stylus x 2

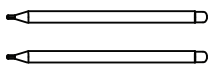

## User Guide

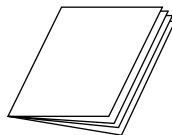

## Wall Mounting Bracket

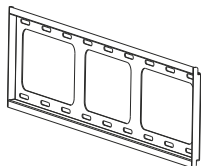

## Vertical Brackets x 2

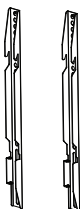

## M8 Screw x 4 (20mm length)



## M6 Self-tap Screw x 8 (50mm length)



## Expansion Rubber x 8

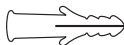

## M8 Flat Washer x 8



## M5 Screw x 2 (100mm length)

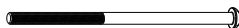

Note: The M5 screws come attached to the vertical brackets.

# Installation Steps

## Unpacking

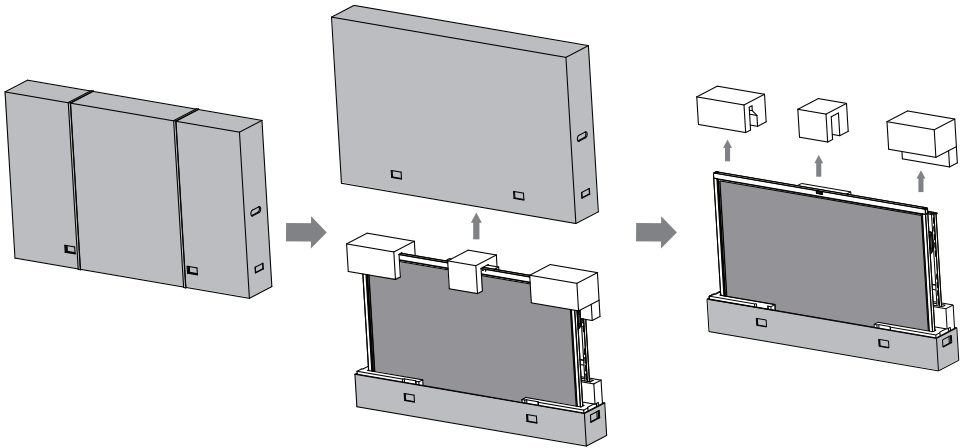

## Install the Vertical brackets

Attach the vertical brackets to the back of the Interactive Flat Panel.

**Note:** The appearance of the back varies depending on its size.

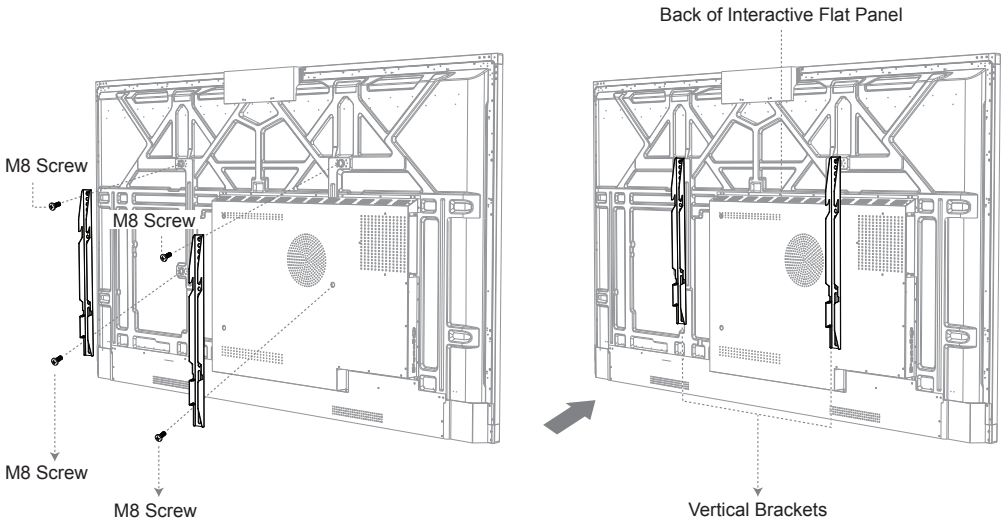

Hold the **Wall Mounting Bracket** steadily against the wall, ensuring it is level. Then, mark the 8 positions for the drill-in mounting holes. Next, use the supplied **M6 self-tap screws** and **M8 flat washers** to attach the mounting bracket to the wall. Tighten each bolt with a socket wrench as shown in the following diagram.

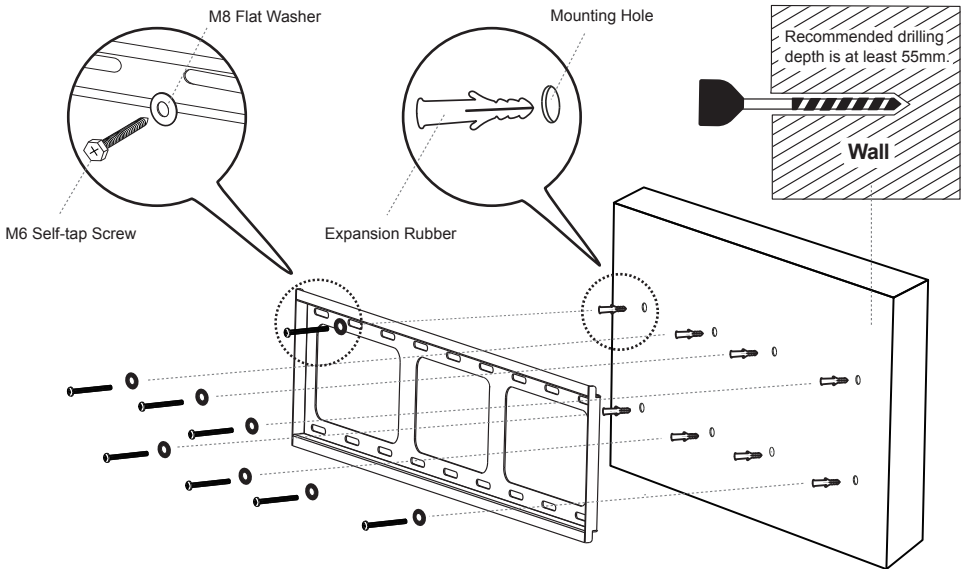

Mount the panel vertically on the bracket to complete installation and ensure that the panel is kept in the center of the bracket. Then, tighten the M5 screw bolt on the vertical bracket and secure it to the wall mounting bracket.

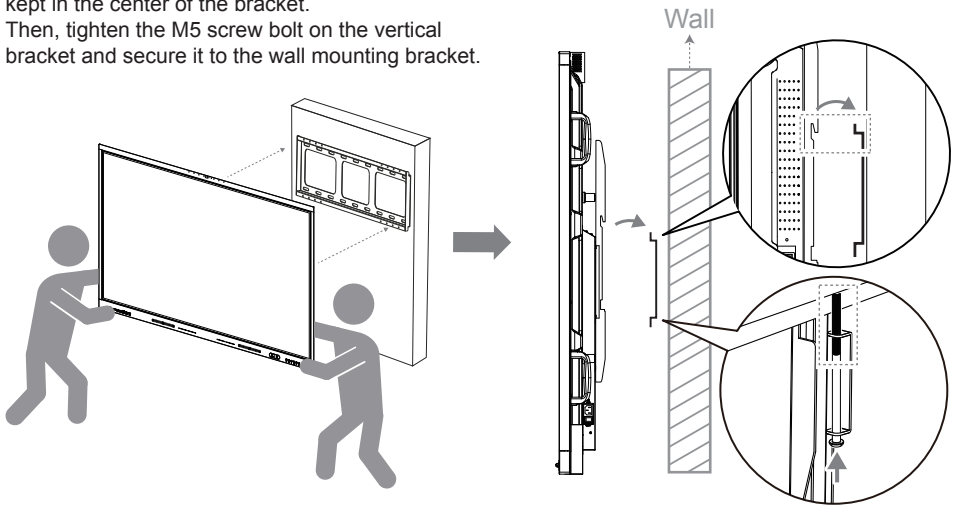

**Note:** It's recommended to have at least two people install the wall mounting bracket simultaneously. Avoid self-installation to prevent injury due to improper operation.

## Connect The Power Cord

1. Plug the power cord into the power socket of the product.
2. Connect the plug to the power supply.

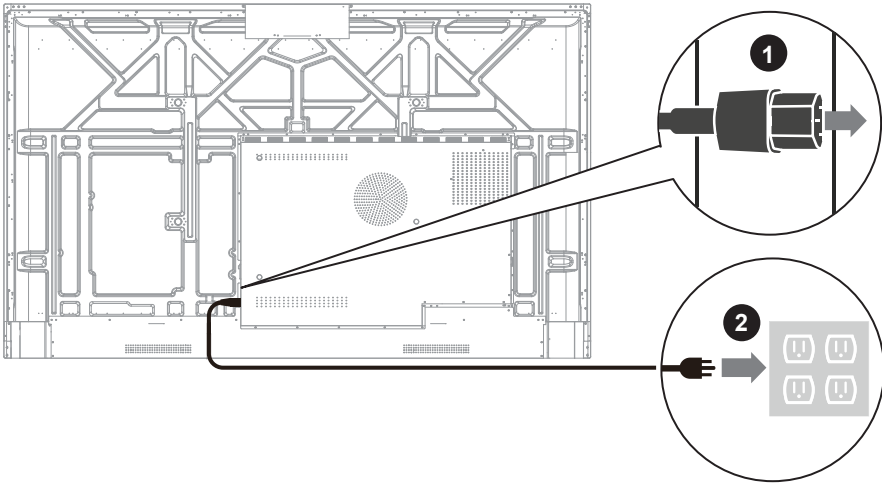

## Turn On The Power

1. Turn on the power switch from the back side.
2. Press the power button to boot the product until the indicator turns white.

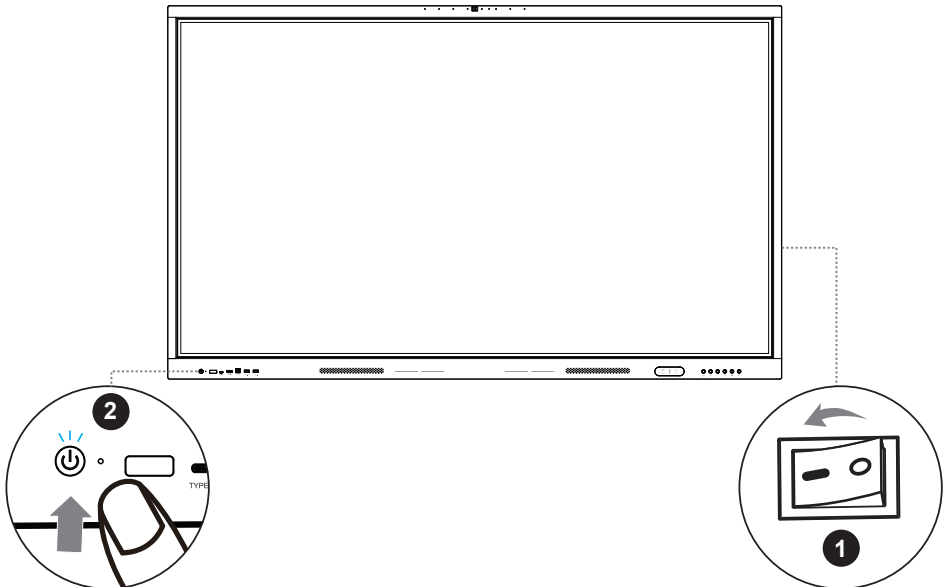



# Product Function Description:

---

The front interface, button functions, and silkscreen descriptions may vary depending on the model. Please refer to the actual product for accurate details.

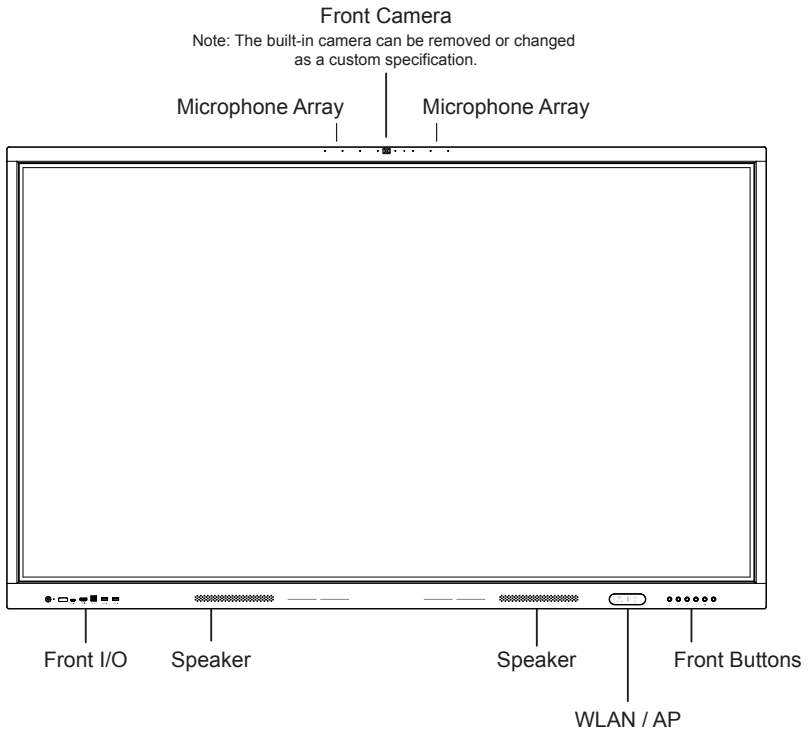

## Key Features:

- Tempered protective glass
- Infrared touch technology
- Built-in Android 13, supporting Dual-OS (Android and Windows)
- Built-in Wi-Fi module (Wi-Fi 6)
- Supports full-channel touch writing and annotation functions
- Supports area and full-screen screenshots in any channel
- Embedded interactive whiteboard software
- Comes with a hideable floating toolbar for quick operations
- Powerful audio and video processing technology, built-in ViiTalk Remote Classroom software

# Front Interface:

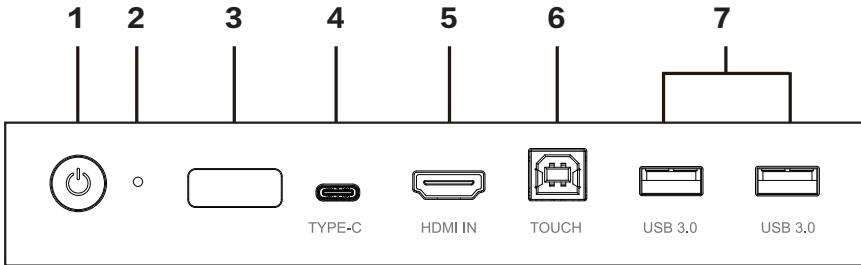

Item	Function	Description
<b>1</b>	Power Button / LED Indicator	<ul style="list-style-type: none"> <li>• Press briefly to turn on the display or switch from On to Standby Mode.</li> <li>• Press and hold for 2 seconds to turn off the display to Standby Mode. (Note: when entering Standby Mode, the screen will display a 9-second countdown)</li> </ul> <p><b>LED Indicator Status:</b></p> <p><b>Power Off:</b> No Light (When disconnected from power)</p> <p><b>Powered On:</b> White light emitted</p> <p><b>Standby Mode:</b> Red light emitted</p> <p><b>Sleeping Mode:</b> Red and White flashing</p>
<b>2</b>	Reset	Press and hold to reset the OPS
<b>3</b>	Light Sensor / IR receiver	Ambient Light Sensor / Infrared Signal Receiver
<b>4</b>	Type-C	For connecting to external USB devices (Supports DP with 65W)
<b>5</b>	HDMI IN	For HDMI High Definition Audio and Video Signal Input
<b>6</b>	TOUH	For PC connectivity with touch control
<b>7</b>	USB 3.0	For connecting to external USB devices

# Front Buttons:

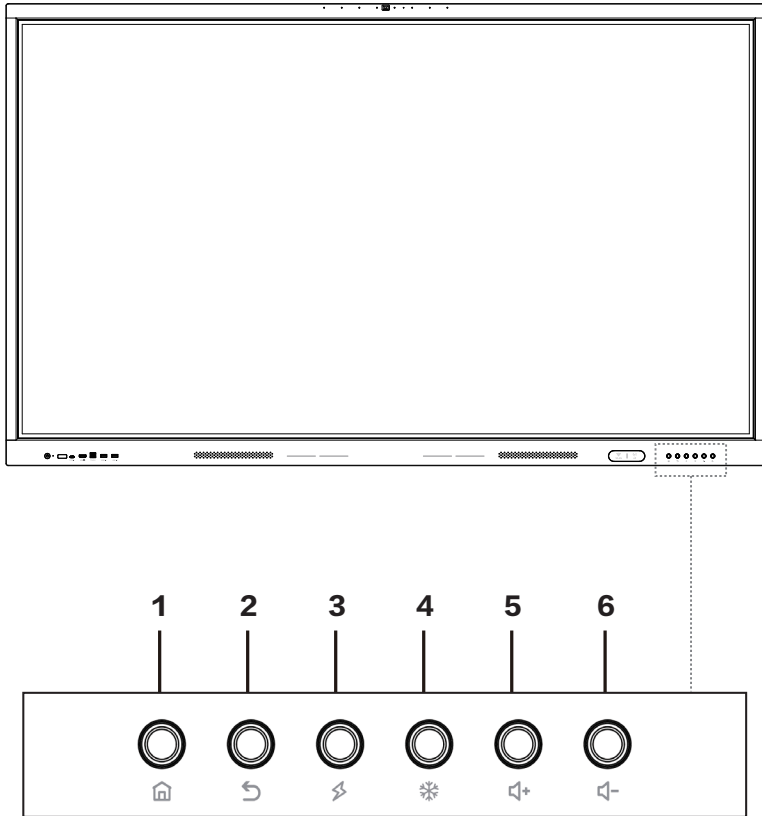

Item	Function	Description
<b>1</b>	Home	Single press to go to the home screen
<b>2</b>	Back	Single press to return to the previous menu
<b>3</b>	Quick Seeting	Single press to open the settings menu
<b>4</b>	Freeze	Single press to freeze / unfreeze the screen
<b>5</b>	Volume up	Single press to increase volume
<b>6</b>	Volume down	Single press to decrease volume

# Back Interface:

**NOTE:** The product back and rear cover may vary in size depending on the model. Please refer to the actual product for accuracy.

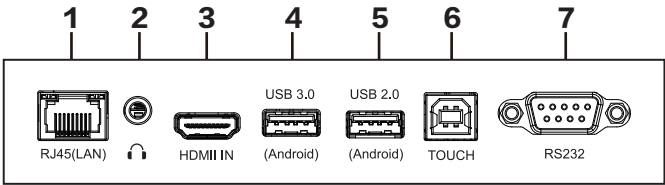
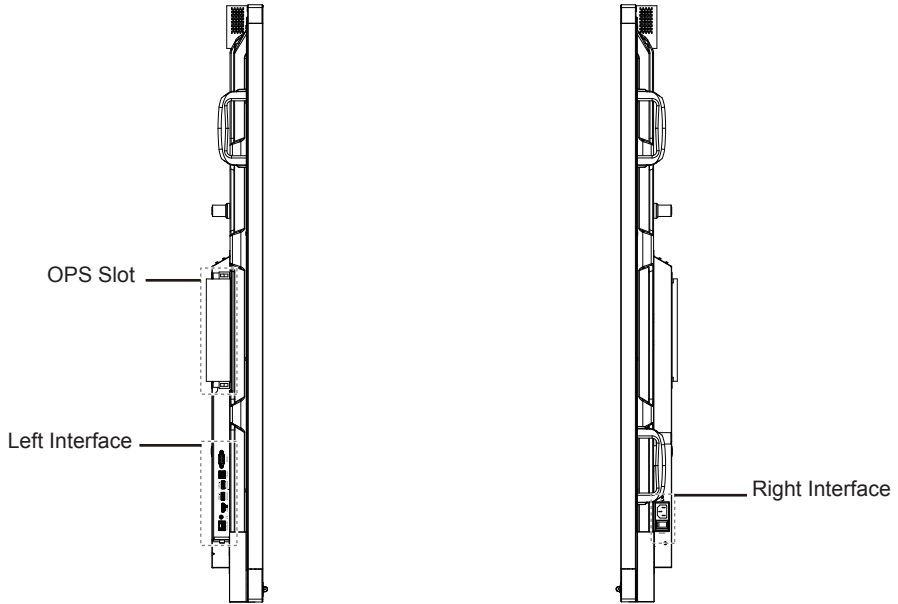

Item	Function	Description
1	RJ45 (LAN)	Connect the RJ-45 ethernet
2	Headphone jack	External headphone audio output
3	HDMI 1/2	HDMI high-definition audio and video signal input
4	USB 3.0(Android)	For connecting external USB 3.0 devices to Android system
5	USB 2.0(Android)	For connecting external USB 2.0 devices to Android system
6	TOUCH	For PC connectivity with touch control
7	RS232	For connecting a central control device with an RS232 interface

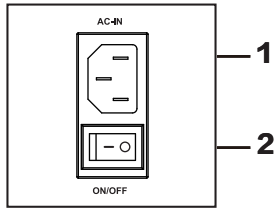

Item	Function	Description
<b>1</b>	AC-IN	Power outlet
<b>2</b>	ON/OFF	Power Switch "I" indicates the Power-On state, "O" indicates the Power-Off state.

## Bottom Interface:

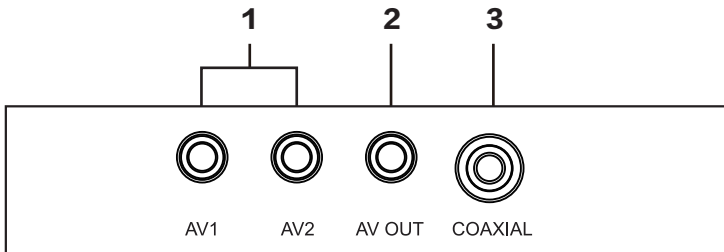
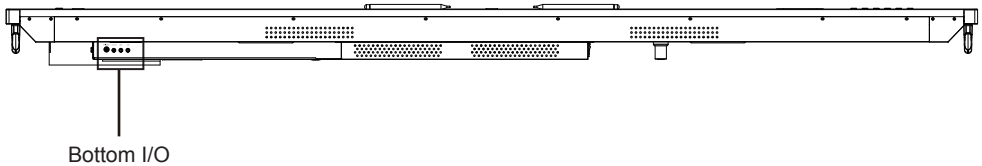

Item	Function	Description
<b>1</b>	AV1	For connecting to audio input device
<b>2</b>	AV2	For connecting to audio input device
<b>3</b>	Audio Out	For connecting to audio output device
<b>3</b>	COAXIAL	Transmit digital audio signals

# External Computer & Touch Control Connection

## Reverse Touch Control Connection

1. Connect one end of the HDMI cable to the computer's HDMI output port, and the other end to the Interactive Flat-Panel's HDMI input port.
2. Connect the USB cable from the external computer's USB port to the Interactive Flat-Panel's USB Touch port.
3. Start the external computer.
4. Start the Interactive Flat-Panel.
5. Select the signal source of the Interactive Flat-Panel to the external computer channel.

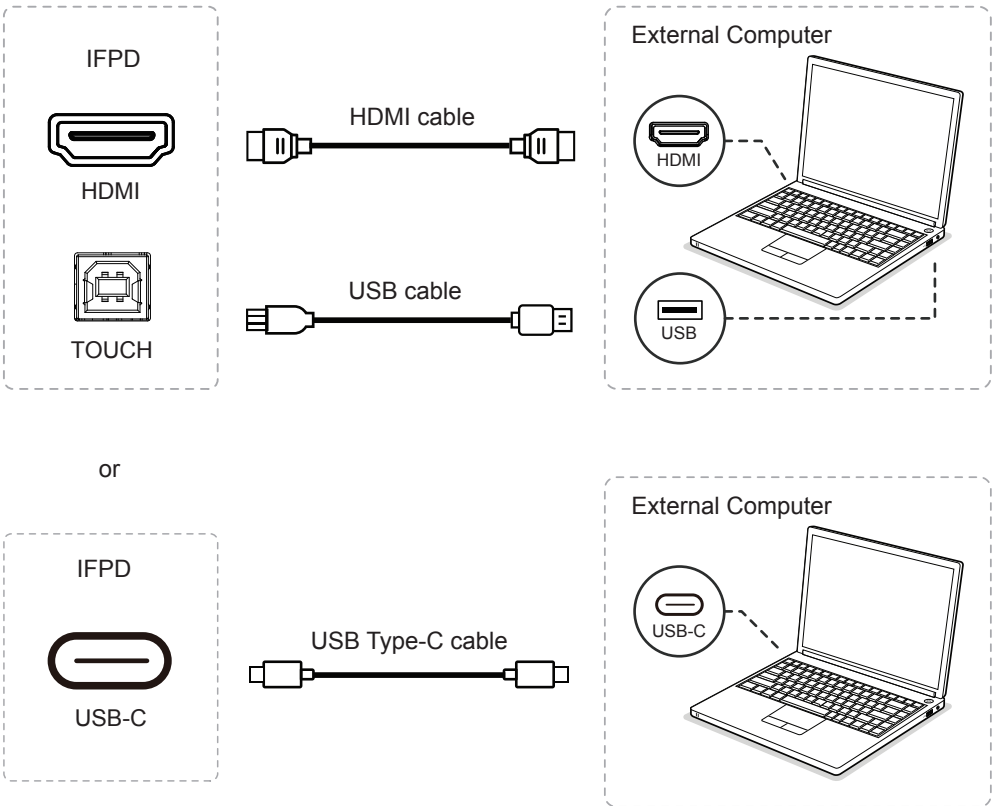

# Interface function

## HDMI Signal input

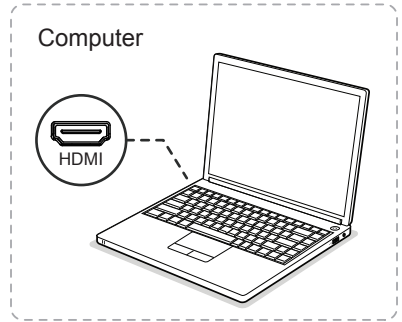
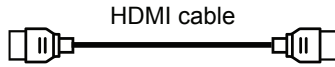
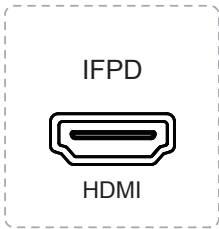

## RS232 device connection

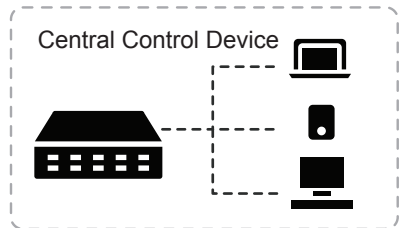
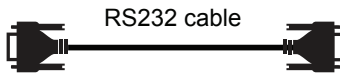
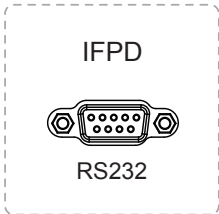

## USB device connection

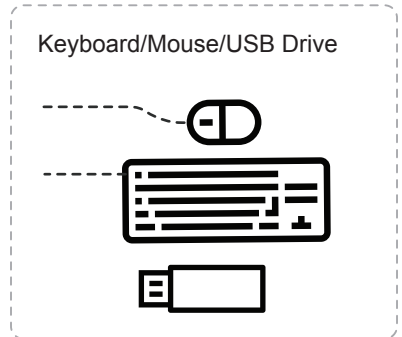
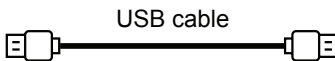
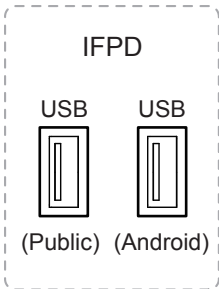

## Audio signal output

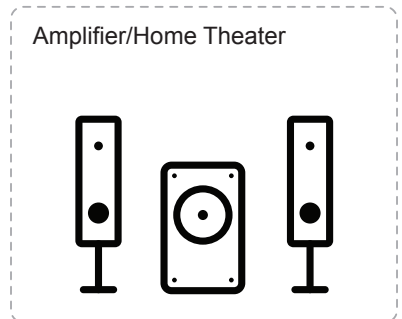
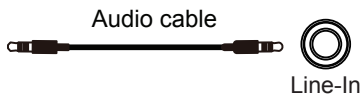
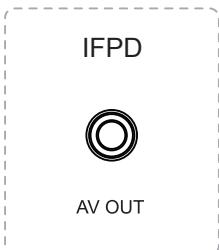

# Remote Control Function Keys Description

## Precautions when using remote control

1. Ensure the remote control towards the display's IR sensor for effective operation.
2. Avoid excessive vibration when handling the remote control.
3. Direct sunlight or strong lighting on the sensor window may cause malfunction; adjust lighting or angle if necessary.
4. Replace low batteries promptly to maintain optimal performance; remove batteries if not using for an extended period to prevent corrosion.
5. Use only one type of battery, avoid mixing old and new, and follow proper disposal guidelines; never dispose of batteries in fire or attempt to charge, disassemble, or short-circuit them.
6. Prevent exposure to extreme heat or sunlight to avoid battery damage.

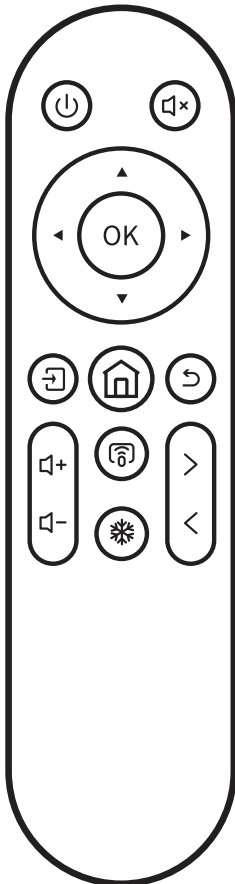

Functions	Description
	Long-press turn on Power On/Off Short-press enter to sleep mode
	Mute / Unmute Audio
	Up / Down
	Left / Right
OK	Confirm / OK
	Enter the Source Selection Page
	Go to the Home Page
	Return to Previous / Exit
	Volume Up
	Volume Down
	Android Screen Casting
	Freeze / UnFreeze the Screen
	Go back to the previous page
	Go to the next page



# Installing the OPS computer (Optional)



## CAUTION

1. The OPS computer does not support hot plugging. Therefore, you must insert or remove the OPS computer when the display is powered off. Otherwise, the Interactive Flat-Panel or OPS computer may be damaged.
2. Additionally, you will need to purchase the OPS computer separately and follow the steps below to install the OPS.

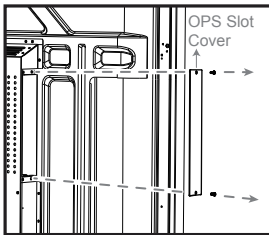

### Step 1:

Loosen the external M3 screws of the OPS slot on rear of the interactive flat-panel and remove the cover.

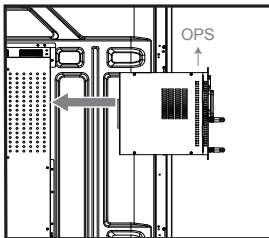

### Step 2:

Insert the OPS computer into the OPS slot on the rear of the interactive flat-panel.

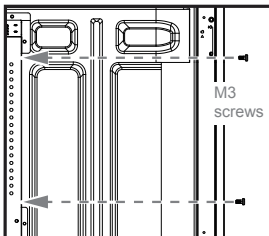

### Step 3:

Secure the OPS computer to the interactive flat-panel by using the M3 screws.

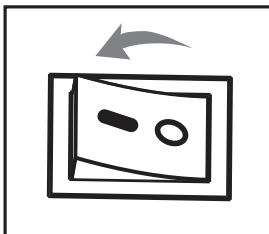

### Step 4:

Ensure the installation is correct before turning the power on again.

# Maintenance

Protecting the product from dust and moisture will help prevent unexpected failures. Please clean the product regularly with a soft, dust-free, dry cloth. Ensure to unplug the product before cleaning.

## Cleaning the Screen

1. Dissolve fabric softener or detergent in 75% alcohol.
2. Soak a piece of soft cloth in the solution.
3. Squeeze the cloth dry before use.
4. Do NOT allow the cleaning solution to drip onto other components of the product.

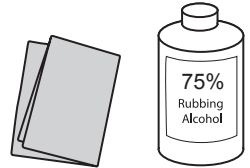

## Cleaning the Touch Frame

Clean the touch frame with dry, soft, lint-free wipes.

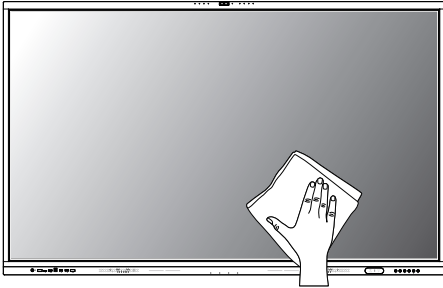

## Long Periods of IFP Inactivity:

When the product is not used for an extended period, be sure to unplug the power plug to prevent potential damage to the product from power surges such as lightning.

1. Turn off the power switch of the interactive flat panel.
2. Unplug the power cord from the interactive flat panel.
3. Unplug the external power plug.

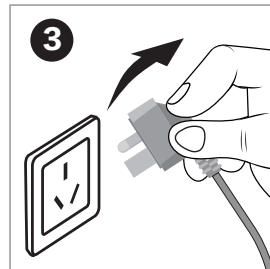
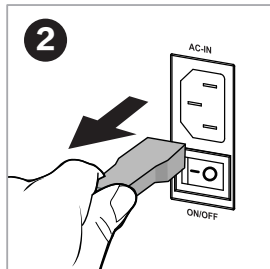
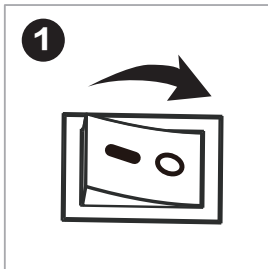

# Hazardous Materials Table

Part Name	Toxic and Hazardous Substances or Elements					
	Lead (Pb)	Mercury (Hg)	Cadmium (Cd)	Hexavalent chromium (Cr6+)	Polybrominated biphenyls (PBB)	Polybrominated diphenyl ethers (PBDE)
Display	×	○	○	○	○	○
Housing	○	○	○	○	○	○
PCBA Components*	×	○	○	○	○	○
Power Cord and Cables	×	○	○	○	○	○
Metal Parts	○	○	○	○	○	○
Packaging Materials*	○	○	○	○	○	○
Remote Control	×	○	○	○	○	○
Speakers	×	○	○	○	○	○
Accessories*	○	○	○	○	○	○

This table is prepared in accordance with the provisions of GB/T 26572

\*: The circuit board components include PCBs and the electronic elements that constitute them; packaging materials include packaging boxes, protective foam (EPE), etc.; other accessories include user manuals, etc.

○: Indicates that said hazardous substance contained in all of the homogeneous materials for this part is below the limit requirement of GB/T 26572.

×

Indicates that said hazardous substance contained in at least one of the homogeneous materials used for this part is above the limit requirement of GB/T 26572.

This table indicates that the machine contains harmful substances. The data is based on material types provided by material suppliers and verified by us. Some materials contain harmful substances that cannot be replaced according to current technological standards. We are continuously striving to improve this aspect.



The environmental use period of this product is 10 years. The symbol indicating restricted use of hazardous substances is shown in the left image. The product's service life refers to its effectiveness when used under normal conditions as specified in the product manual.



The symbol of the crossed-out wheeled bin indicates that this product should not be placed in municipal waste. Instead, dispose of waste equipment by taking it to a designated collection point for electrical and electronic equipment recycling.

